

平板闸阀

产品概述 Product overview

平板闸阀适用于天然气、石油、化工、环保、城市管道、燃气管线等输送管线，放空系统和汽储存装置上，用作启闭设备。

Flat gate valve is suitable for natural gas, petroleum, chemical industry, environmental protection and urban pipeline, gas pipeline transportation pipeline, vent steam system and the storage device, used for opening and closing device.

产品特点 Product features

- 平行单、双闸板自紧式结构，阀座为活塞效应密封性能可靠。
- 密封面采用金属对金属，金属对金属 + 密封脂，或金属对聚四氟乙烯 + 金属 + 密封脂。
- 可满足零泄漏要求。
- 可对密封面自动注脂，密封性能可靠，使用寿命长。
- 流阻系数小，启闭力小，操作方便、灵活。
- 结构先进，维护保养方便。
- 带导流孔闸阀，可满足通球扫线要求。
- 驱动方式有手动、伞齿轮（或正齿轮）传动、电动、气动和液动等。
- Low parallel single and double ram self-tightening type structure, seat for the piston effect sealing performance and reliable.
- Seal face with metal to metal, metal to metal + sealing grease. Or metal for ptfе + + sealing grease.
- Second-ranking can satisfies the requirement of zero leakage.
- To seal face automatic greasing, reliable sealing performance, long service life.
- Low coefficient of flow resistance is small, opening and closing force is small, easy to operate, flexible.
- Advanced structure, easy maintenance.
- Gate valve with flow guide hole, can meet the requirements of ball-passing sweep line.
- Low drive mode manual and bevel gear or spur gear drive, electric, pneumatic, hydraulic, etc.

执行标准 Administer Standard

设计标准 Design standard	结构长度 Structural length	连接法兰 Flanged ends	试验和检验 Inspection and test	压力 - 温度 Pressure Temperature
JB/T 5298 GB/T19672	JB/T 5298 GB/T19672	JB/T 79 GB/T12224	JB/T5298/9092	JB 9131

压力试验 Pressure test (MPa)

压力等级 Pressure rating	常温下试验压力 (MPa) Normal temperature test pressure				适用温度℃ Applicable temperature			适用介质 Applicable medium	
	壳体 Shell	左密封 The left sealing	右密封 Right sealing	低压密封 Low pressure seal	"G" 型 "G" type	"D" 型 "D" type	普通型 Ordinary type	"抗硫" 型 "Sulfur"	"基本" 型 The "basic"
公称压力 Nominal pressure	1.6	2.4	1.76	1.76	-29~250	-46~121	-29~121	H2S 和 Co2 总含量大于 500mg/m ³ 的介质 H2S and Co2 Total content Greater than 500mg / m ³ Medium	石油、 天然气、 水等 Petroleum, Natural gas, Water
	2.5	3.57	2.75	2.75					
	4.0	6.0	4.4	4.4					
	6.4	9.6	7.04	7.04					
磅级 Lb Class Lb	150	3.0	2.2	2.2	-29~250	-46~121	-29~121	H2S 和 Co2 总含量大于 500mg/m ³ 的介质 H2S and Co2 Total content Greater than 500mg / m ³ Medium	石油、 天然气、 水等 Petroleum, Natural gas, Water
	300	7.7	5.6	5.6					

主要零件材料 The major parts material

阀门 / 阀盖 Valve / valve cover	WCB	WC6	A352-LCB	A351-CF8M
闸板 Gate	2Cr13+ENP	20CrMoV+STL	ANSI 410+ENP	ANSI 316+ENP
阀杆 Valve stem	2Cr13	2Cr13	A182-F6a	A182-F316S
阀座 Valve seat	25+PTFE	20CrMoV+STL	A105+PTFE	A182-F316+PTFE
填料 Filler	NBR/FPM	柔性石墨 Flexible graphite		PTFE+FPM
垫片 Shim	18-8/ 柔性石墨 Flexible graphite			
螺栓 Bolt	35	35CrMo	A193-B7M	A193-B8
适用介质 Applicable medium	水、油品、蒸汽 Water, oil, steam	蒸汽、油品 Steam, oil	丙烷、乙烯 Propane, ethylene	硝酸类 Nitric acid

平板闸阀

工作原理 working principle

● 阀门内部压力相当时 (1)，闸板处于闭合状态，阀座表面 PTFE 密封环形成初始密封，每次阀门开或关时，阀座圈能清洁闸板两侧。(如图 1)

● the pressure within the valve is quite (1), when the disc in the closed state, the seat surface of the PTFE seal form initial, each valve open or close, the seat ring can clean the gate on both sides. (as shown in figure 1)

● 对阀门施加管道压力时 (2)，压力作用于闸板，迫使它贴近出口阀座上的 PTFE 环，压缩它直到闸板停在钢制阀座上，这样就形成了双重密封，首先是 PTFE 对金属密封，然后是金属对金属密封，阀座也被牢固地推到凹槽，在这一点 (3)，O 形圈阻止任何后部介质流。(如图 2)

● the valve (2) when the pipeline pressure, the pressure acting on the gate, forcing it to export of PTFE on the seat ring, compress it straight to ram stops in the steel seat, such, is formed the double seal, PTFE is first and foremost to metal seal, and then the metal to metal seal, the seat is also firmly pushed into the groove and at this point (3), o-ring block any medium to flow in the back. (as shown in figure 2)

● 阀腔压力泄放后，形成进口密封，管道压力作用于进口阀座 (4)。使其移向闸板，这时形成 PTFE 对金属的密封，同时，O 形圈 (5) 与阀座凹槽形成紧密的密封。(如图 3)

● after the pressure relief valve cavity, the formation of imported seals, pipe pressure ACTS on the inlet valve seat (4). Make its move to ram, formation of PTFE sealing of metal at this moment, at the same time, the O ring (5) and seat groove form a tight seal. (as shown in figure 3)

● 阀门自动泄放多余的压力，当阀腔压力大于管道压力时，由于热膨胀，进口阀座推向凹槽，阀腔内多余的压力在阀座与闸板之间泄放到管道中。(如图 4)

● the valve automatically discharge excess pressure, when the valve chamber pressure is greater than the line pressure, due to thermal expansion, import the seat into the grooves, excess pressure cavity drainage on the pipeline between the seat and disc. (as shown in figure 4)

各类型闸板外形图 Each type of damper figure shape

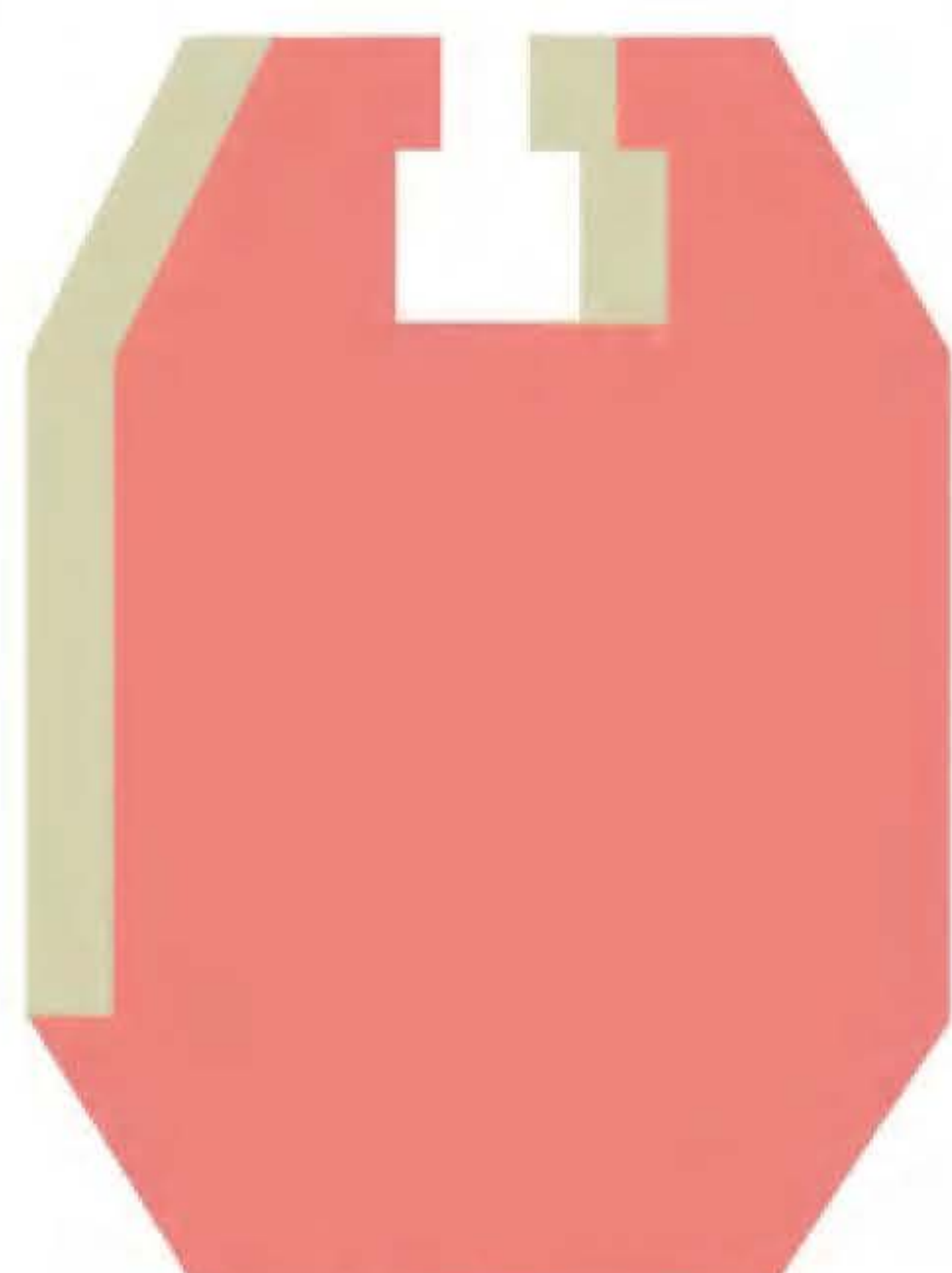

普通型闸板
Ordinary type ram

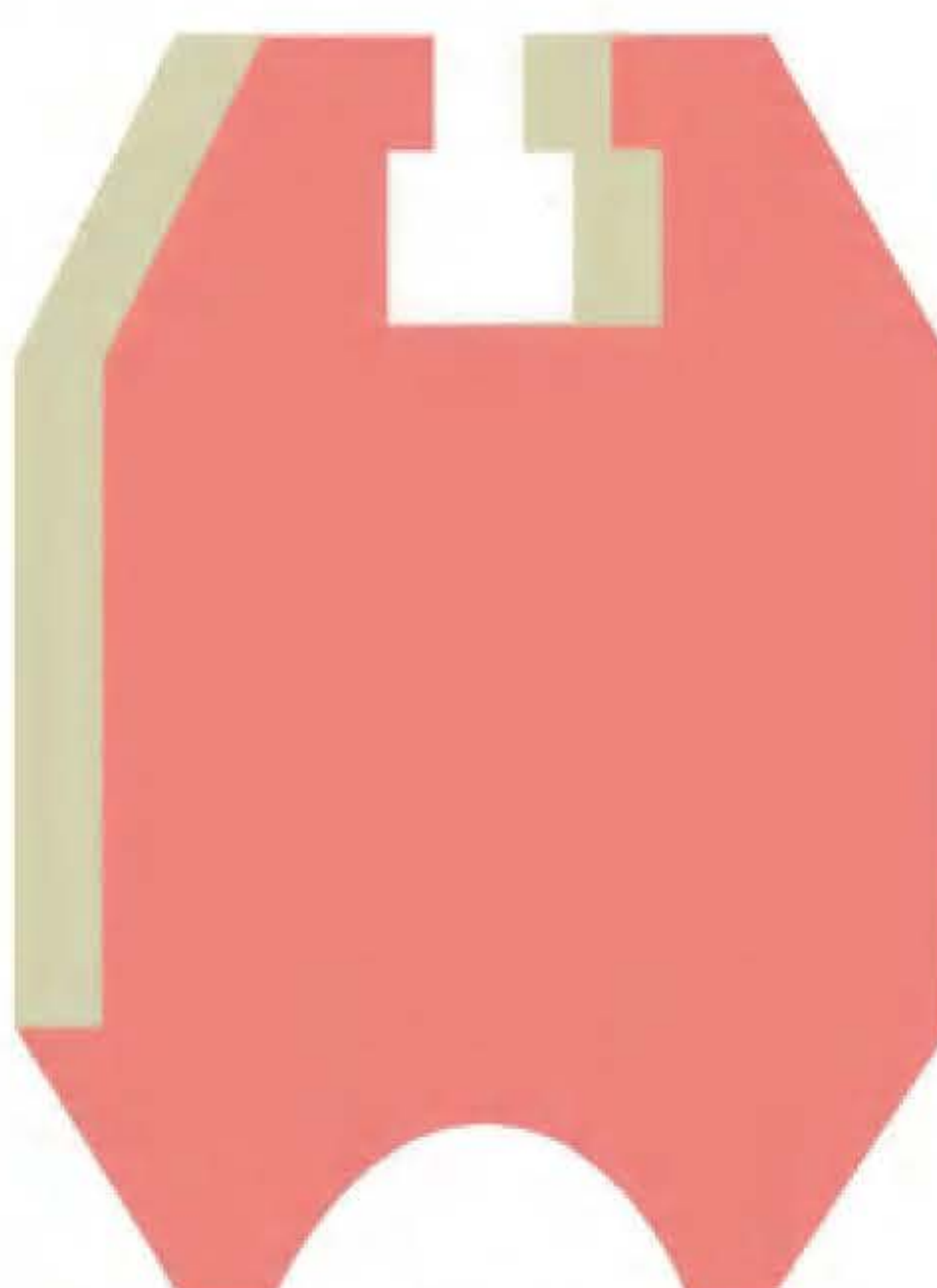

调节型闸板
Adjust type ram

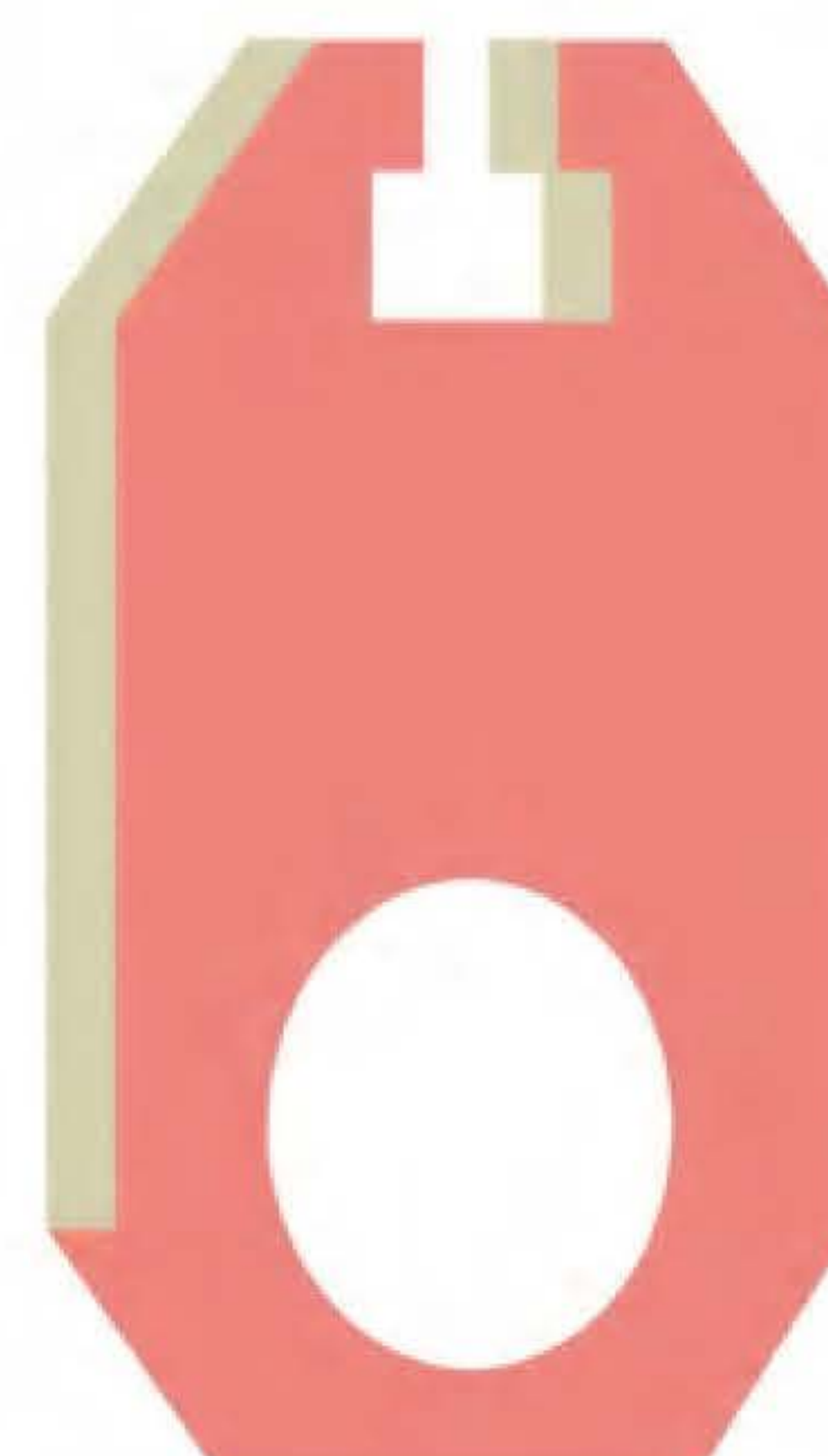

带导流孔型闸板
With diversion hole type ram

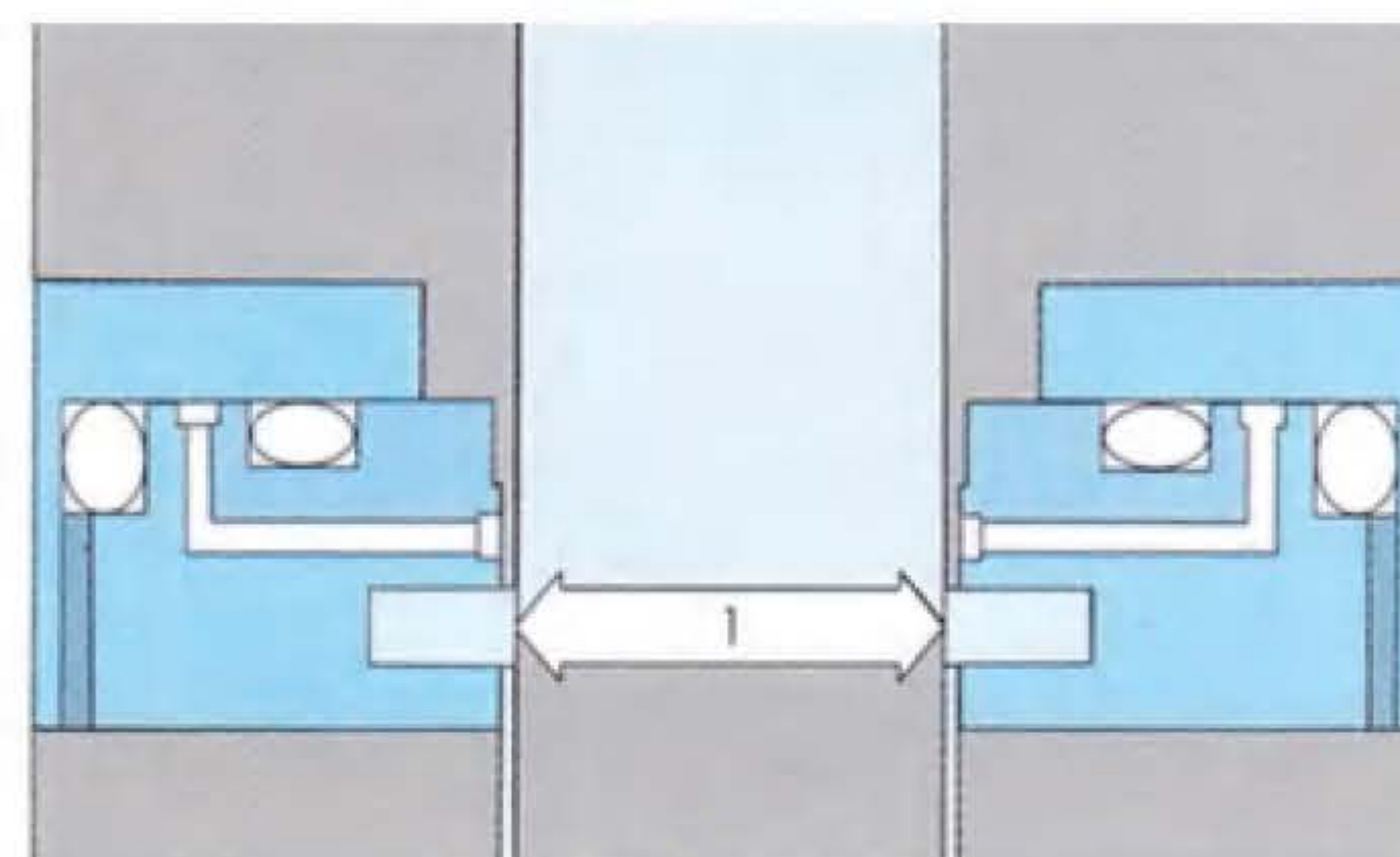

(如图 1) figure 1

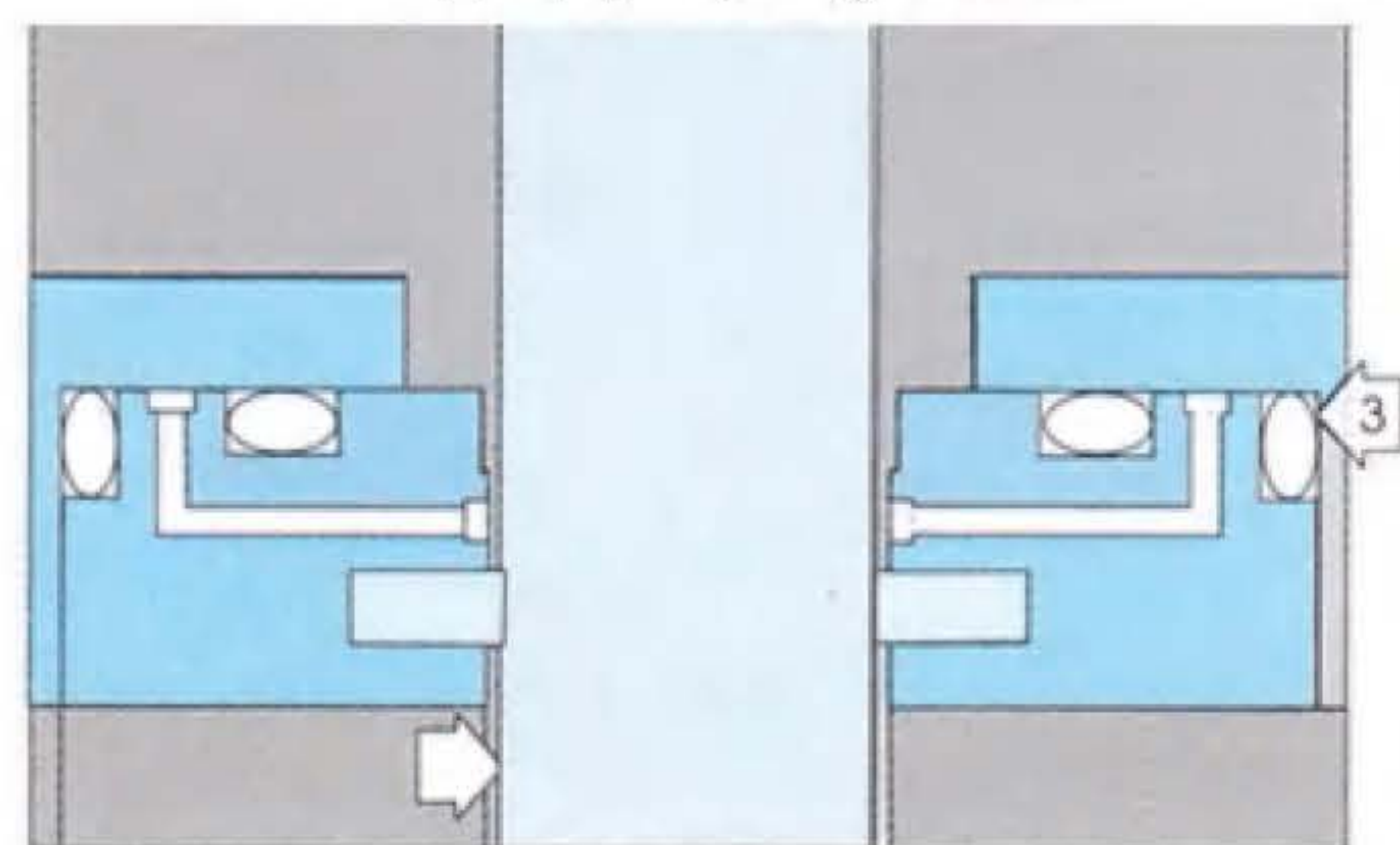

(如图 2) figure 2

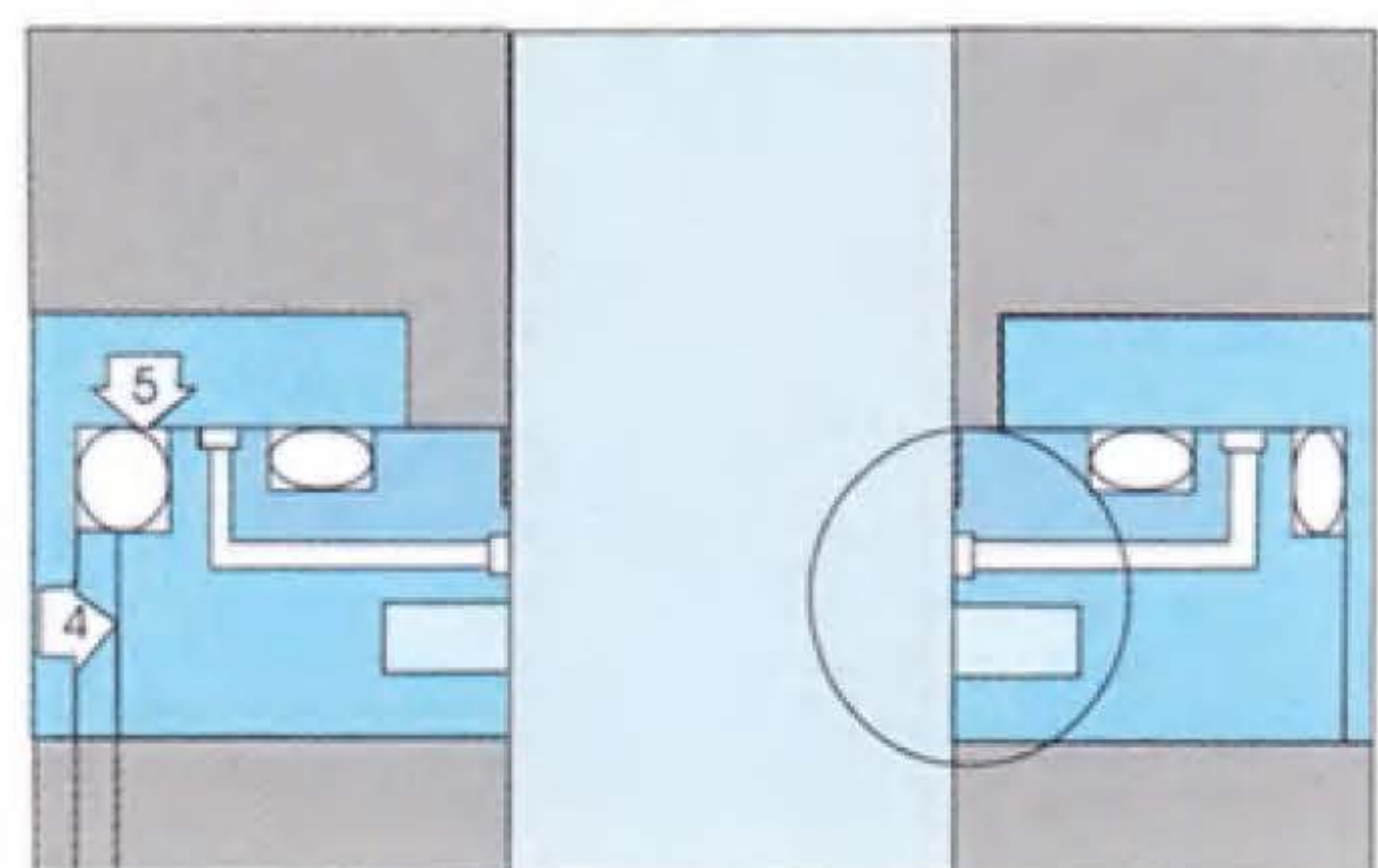

(如图 3) figure 3

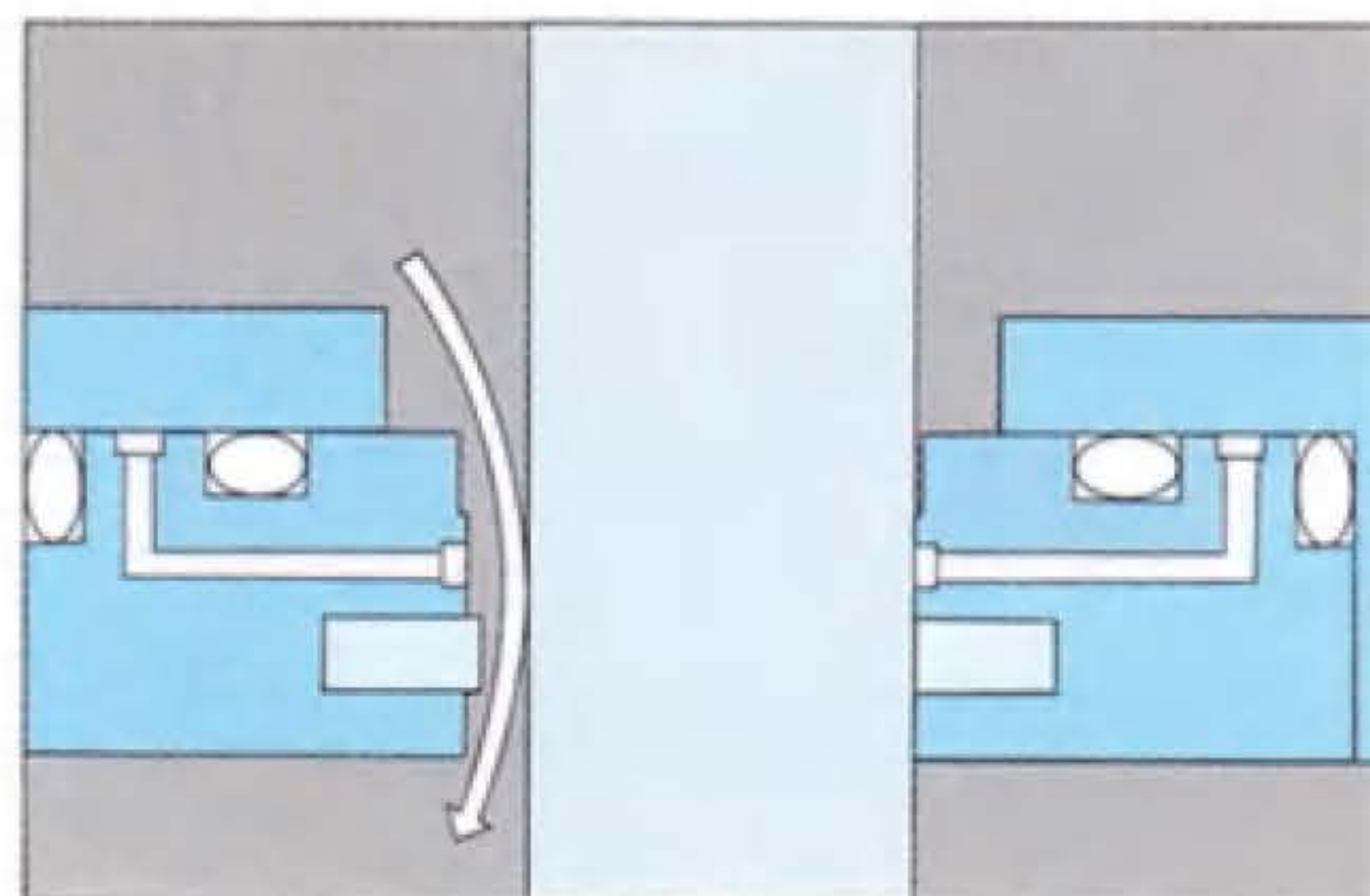

(如图 4) figure 4

平板闸阀

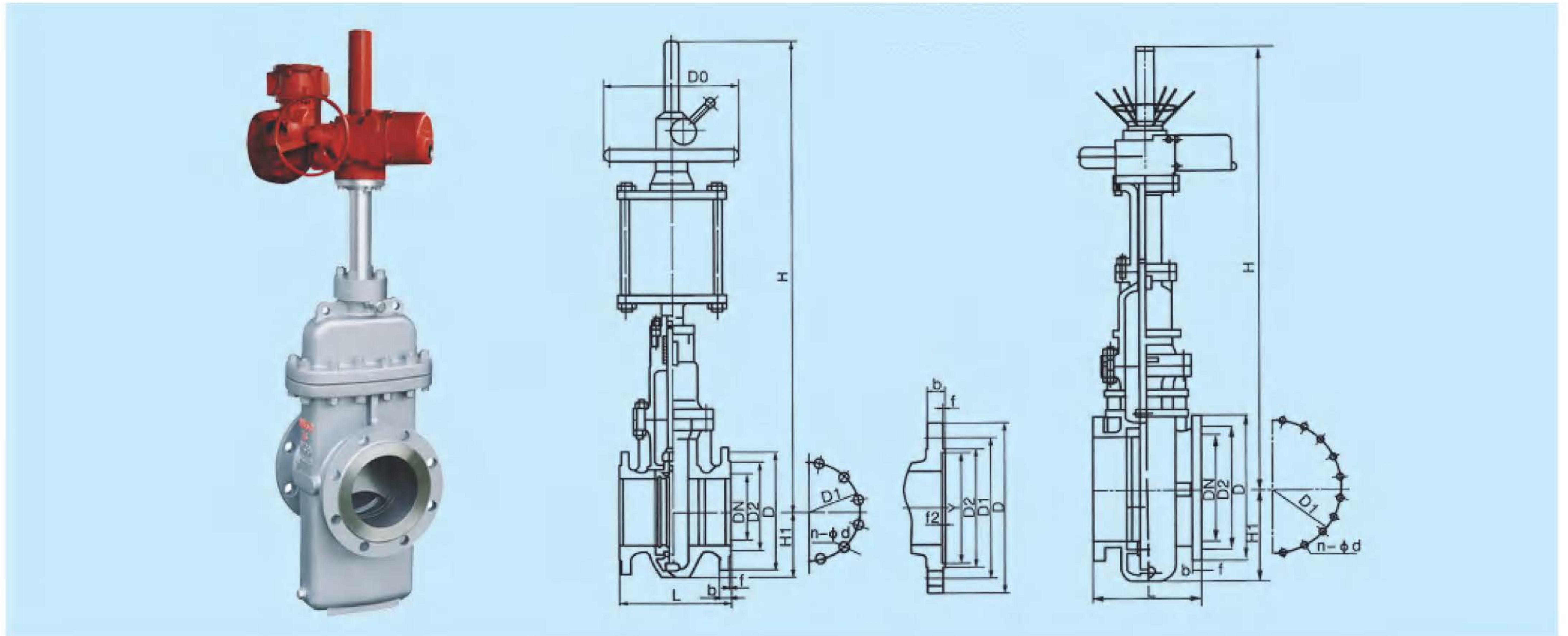

主要外形尺寸 (mm) Main External and Connection Dimension

型号 Type	DN	L	D	D1	D2	Do	f	b	H	H1		n-Φd
										无导流 Without a guide	有导流 With the diversion	
(K) Z43WF/F-16C (K) Z543WF/F-16C (K) Z643WF/F-16C (K) Z943WF/F-16C	50	178	160	125	100	250	3	16	584	85	122	4-Φ18
	65	191	180	145	120	250	3	18	634	91	154	4-Φ18
	80	203	195	160	135	250	3	20	688	109	169	8-Φ18
	100	229	215	180	155	300	3	20	863	121	193	8-Φ18
	125	254	245	210	185	350	3	22	940	132	245	8-Φ18
	150	267	280	240	210	350	3	24	1030	178	283	8-Φ23
	200	292	335	295	265	350	3	26	1277	211	352	12-Φ23
	250	330	405	355	320	400	3	30	1491	215	440	12-Φ25
	300	356	460	410	375	450	4	30	1701	245	514	12-Φ25
	350	381	520	470	435	500	4	34	1875	280	602	16-Φ25
	400	406	580	525	485	305	4	36	2180	310	678	16-Φ30
	450	432	640	585	545	305	4	40	2440	346	785	20-Φ30
	500	457	705	650	608	305	4	44	2860	363	855	20-Φ34
	600	508	840	770	718	305	5	48	3450	442	1045	20-Φ41
	700	610	910	840	788	305	5	50	3960	505	1190	24-Φ41
800	660	1020	950	898	305	5	52	4550	560	1350	24-Φ41	
900	711	1120	1050	998	250	5	54	5250	610	1510	28-Φ41	
1000	812	1255	1170	1110	250	5	56	5870	715	1715	28-Φ48	
(K) Z43WF/F-25 (K) Z543WF/F-25 (K) Z643WF/F-25 (K) Z943WF/F-25	50	178	160	125	100	250	3	20	584	85	85	4-Φ18
	65	191	180	145	120	300	3	22	634	91	91	8-Φ18
	80	203	195	160	135	350	3	22	688	109	109	8-Φ18
	100	229	230	190	160	350	3	24	863	121	121	8-Φ23
	125	254	270	220	188	350	3	28	940	132	132	8-Φ25
	150	267	300	250	218	400	3	30	1030	178	178	8-Φ25
	200	292	360	310	278	450	3	34	1277	211	211	12-Φ25
	250	330	425	370	332	500	3	36	1491	215	215	12-Φ30
	300	356	485	430	390	305	4	40	1701	245	245	16-Φ30
	350	381	550	490	448	305	4	44	1875	280	280	16-Φ34
	400	406	610	550	505	305	4	48	2180	310	310	16-Φ34
	450	432	660	600	555	305	4	50	2440	346	346	20-Φ34
	500	457	730	660	610	305	4	52	2860	363	363	20-Φ41
	600	508	840	770	718	305	5	56	3450	442	442	20-Φ41
	700	610	955	875	815	305	5	60	3960	505	505	24-Φ48
800	660	1070	990	930	305	5	64	4550	560	560	24-Φ48	
900	711	1180	1090	1025	305	5	66	5250	610	610	28-Φ54	
1000	812	1305	1210	1140	305	5	68	5870	715	715	28-Φ58	

平板闸阀

主要外形尺寸 (mm) Main External and Connection Dimension

型号 Type	DN	L	D	D1	D2	Do	f	b	H	H1		n-Φd
										无导流 Without a guide	有导流 With the diversion	
(K) Z43WF/F-40 (K) Z543WF/F-40 (K) Z643WF/F-40 (K) Z943WF/F-40	50	250	160	125	100	250	3	20	584	85	122	4-Φ18
	65	280	180	145	120	250	3	22	634	91	154	8-Φ18
	80	310	195	160	135	250	3	22	679	109	169	8-Φ18
	100	350	230	190	160	300	3	24	863	121	193	8-Φ23
	125	400	270	220	188	350	3	28	940	132	245	8-Φ25
	150	450	300	250	218	350	3	30	1040	178	283	8-Φ25
	200	550	375	320	282	350	3	38	1282	211	352	12-Φ30
	250	650	445	385	345	400	3	42	1495	215	440	12-Φ34
	300	750	510	450	408	450	4	46	1701	245	514	16-Φ34
	350	850	570	510	465	500	4	52	1880	280	602	16-Φ34
	400	950	655	585	535	305	4	58	2200	310	678	20-Φ41
	450	1050	680	610	560	305	4	60	2480	346	785	20-Φ41
	500	1150	755	670	612	305	4	62	2890	363	855	20-Φ48
	600	1350	890	795	730	305	5	62	3460	442	1045	20-Φ54
	700	1450	995	900	835	305	5	68	3985	505	1190	24-Φ54
800	1650	1135	1030	960	305	5	76	4750	560	1350	24-Φ58	
(K) Z43WF/F-64 (K) Z543WF/F-64 (K) Z643WF/F-64 (K) Z943WF/F-64	50	250	175	135	105	250	3	26	584	85	122	4-Φ23
	65	280	200	160	130	250	3	28	634	91	154	8-Φ23
	80	310	210	170	140	250	3	30	679	109	169	8-Φ23
	100	350	250	200	168	300	3	32	763	121	193	8-Φ25
	125	400	295	240	202	350	3	36	970	132	245	8-Φ30
	150	450	340	280	240	350	3	38	1038	178	283	8-Φ34
	200	550	405	345	300	350	3	44	1282	211	352	12-Φ34
	250	650	470	400	352	400	3	48	1495	215	440	12-Φ41
	300	750	530	460	412	450	4	54	1965	245	514	16-Φ41
	350	850	595	525	475	500	4	60	2185	280	602	16-Φ41
	400	950	670	585	525	305	4	66	2573	310	678	16-Φ48
	450	1050	715	630	570	305	4	68	2800	346	785	20-Φ48
	500	1150	800	705	640	305	4	70	3280	363	855	20-Φ54
600	1350	930	820	750	305	5	76	3800	442	1045	20-Φ58	
(K) Z43WF/F-100 (K) Z543WF/F-100 (K) Z643WF/F-100 (K) Z943WF/F-100	50	250	195	145	112	250	3	28	590	85	122	4-Φ25
	65	280	220	170	138	250	3	32	640	91	154	8-Φ25
	80	310	230	180	148	250	3	34	680	109	169	8-Φ25
	100	350	265	210	172	300	3	38	870	121	193	8-Φ30
	125	400	310	250	210	350	3	42	980	132	245	8-Φ34
	150	450	350	290	250	350	3	46	1100	178	283	12-Φ34
	200	550	430	360	312	350	3	54	1315	211	352	12-Φ41
	250	650	500	430	382	400	3	60	1605	215	440	12-Φ41
	300	750	585	500	442	450	4	70	1925	245	514	16-Φ48
	350	850	665	560	498	500	4	76	2280	280	602	16-Φ54
400	950	715	620	558	305	4	80	2580	310	678	16-Φ54	